

**STAND
FAN
WITH**



REMOTE CONTROL



INSTRUCTION MANUAL



IMPORTANT SAFEGUARDS

- ❑ Please read these instructions carefully before use.
- ❑ Keep present instructions for future references.
- ❑ Check that your mains voltage corresponds to that stated on the appliance.
- ❑ Only use the appliance for domestic purposes and household or similar applications such as:
 - staff kitchen areas, in shops, offices and other working environments;
 - by clients in hotels, motels and other residential type environments;
 - Environment type like : • Farm Houses • Bed and Breakfast.Only use the appliance in the way indicated in these instructions.
- ❑ Never use this unit near bathtub, shower, wash-hand basins or other containers with water.
- ❑ Never use this apparatus near water projections.
- ❑ Never use this apparatus with the wet hands.
- ❑ If, unfortunately the apparatus is wet, immediately withdraw the cord of the socket-outlet.
- ❑ Inform potential users of these instructions.
- ❑ Never leave the appliance unsupervised when in use.
- ❑ The appliance must be used only for its intended purpose. No responsibility can be taken for any possible damage caused by incorrect use or improper handling.
- ❑ Children and persons with disabilities are not always aware of the danger posed by the use of appliances.
- ❑ This device can be used by children aged 8 years and older and adults, with reduced physical, sensory or mental capabilities or lack of experience and knowledge, if they have been given supervision or instruction concerning use of the

appliance in a safe way and understand the hazards involved.

- ❑ Cleaning and maintenance must not be made by children without supervision.
- ❑ Keep the appliance and its cord out of reach of children aged less than 8 years of age when it is energized or cooling down.
- ❑ This device is not a toy, do not leave children or people with disabilities to play with.
- ❑ In order to ensure your children's safety, please keep all packaging (plastic bags, boxes, polystyrene etc.) out of their reach.
- ❑ Caution ! Do not allow small children to play with the foil :
THERE IS A DANGER OF SUFFOCATION !
- ❑ From time to time check the cord for damages. Never use the appliance if cord or appliance shows any signs of damage.
- ❑ Never immerse the appliance in water or any other liquid for any reason whatsoever.
- ❑ Never place it into the dishwasher.
- ❑ Never use the appliance near hot surfaces.
- ❑ Do not operate the appliance with a damaged cord or plug, or after the appliance has been damaged in any manner.
- ❑ If the supply cord or appliance is damaged, it must be replaced by the manufacturer or its service agent or a similarly qualified person in order to avoid a hazard.
- ❑ Disconnect the power source cable before any operation of cleaning of maintenance and accessories assembly.
- ❑ Never use the appliance outside and always place it in a dry environment.
- ❑ Never use accessories, which are not recommended by the producer. They could constitute a danger to the user and risk to damage the appliance.
- ❑ Never use any other connector than the one provided.

- ❑ Never move the appliance by pulling the cord. Make sure the cord cannot get caught in any way.
- ❑ Never wind the cord around the appliance and do not bend it
- ❑ Ensure that the power cord does not come into contact with hot parts of this unit.
- ❑ Make sure the appliance has cooled down before cleaning and storing it.
- ❑ The temperature of accessible surfaces may be very high when the appliance is operating. Never touch these parts, of apparatus, to avoid burning itself.
- ❑ Make sure the appliance never comes into contact with flammable materials, such as curtains, cloth, etc...& the power cord and plug do not come in contact with water.
- ❑ Before cleaning, always unplug the appliance from the power supply and let it cool down.
- ❑ This appliance is not intended to be operated by means of an external timer or separate remote-control system.
- ❑ Always place the unit on a flat surface. Ensure, also, not to cover the device and not to put anything on it.
- ❑ Always remove the plug from the wall socket when the appliance is not in use.
- ❑ When using an extension lead always make sure that the entire cable is unwound from the reel. Use solely CE approved extension leads. Input power must be at least 16A, 250V, 3000W.
- ❑ Incorrect operation and improper use can damage the appliance and cause injury to the user.
- ❑ This device, designed for home use, complies with standards relating to this type of product.
- ❑ The appliance must be used and rested on a table or flat & stable surface.
- ❑ The item must not be left unattended when it is connected to main supply.

- The item is not to be used, if it has been dropped or if there are visible signs of damage.
- This appliance is only intended for household use.

GENERAL INFORMATION

The symbol "OPEN BOOK" means a recommendation to read important things contained in the record.

The symbol "BIN" crossed out, abbreviation WEEE (Waste of Electrical and Electronic Equipment) means that at the end of life, it should not be discarded with household waste, but filed to the sorting of the locality. Waste recovery can help preserve our environment.

The symbol "CE" is the guarantee of compliance with harmonized European standards, voluntary, reflecting the essential requirements into technical specifications. These standards are not mandatory but are guarantees of compliance with essential requirements.

The symbol ROHS (Restriction of use of some Hazardous Substances) on the Environmental Protection, certifies that for each of the five hazardous substances • Lead • Mercury • (hexavalent) chromium • products for protection against flames PBB and PBDE, the peak concentration is equal to or less than 0.1% of the weight of homogeneous material, and 0.01% for the 6th • cadmium.

The symbol "DOUBLE SQUARE" means a double insulated. A basic insulation and supplementary insulation. This device requires no connection to the mass of a protective conductor grounded. The materials are said : double insulation class II.

Fans for tropical climates

The symbol "TRIMAN" indicates that the consumer is invited to dispose the product as part of a separate collection (eg recycling bin, waste, voluntary intake point).

For more information : <http://www.quefairedemesdechets.fr>

SPECIAL WARNING FOR THIS DEVICE

- Do not carry the unit by holding the power cord.
- Do not insert objects through the protective grill.
- Do not use the device in a bathroom
- Always use the fan with the included foot and upright.

Warning! Never use without the guards in place. After assembly, do not remove the guards for maintenance purpose or cleaning.

TO KNOW IT'S UNIT

1. Front Guard
2. Fan Blade
3. Blade Nut and Screw
4. Rear Guard
5. Motor axis
6. Motor Housing
7. Oscillation Control
8. Control panel
9. Body
10. Pivot safety Screw
11. Adjustable tube
12. Fixing Screws
13. Below tube
14. Base End Caps

CONTROL PANEL

1. Sensor for remote control
2. Indicator Light On function
3. Speed 3 indicator light
4. Speed 2 Indicator light
5. Speed 1 indicator light
6. "Normal Mode" indicator light
7. "Sleep Mode" indicator light
8. 4H timer indicator light
9. 2H timer indicator light
10. 1H timer warning light
11. 30 minutes timer indicator light
12. Inactive Button on this model !

A key Mode: Normal or Standby

B On and Speed selector

C Button timer (each pulse changes the programmed time of use.)

D Stop button of the unit. All indicator lights are off.

ASSEMBLING

- Take the two base cross and push the end caps into the ends. Cross them over together as draw :
- Remove the four screws from the base and pole the below tube & base to the base.
- Slide the screw cover down over the adjustable and lower base until it's hide the screws.
- Replace the pole clamp and raise the adjustable.
- Attach the fan assembly on top of the upper tube and tighten it with retaining screw.
- Place the rear guard onto the motor housing and fix it with Central Fixing nut, by screwing back clock wise.

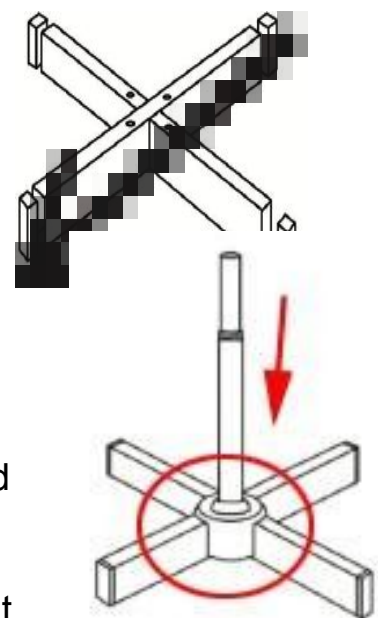



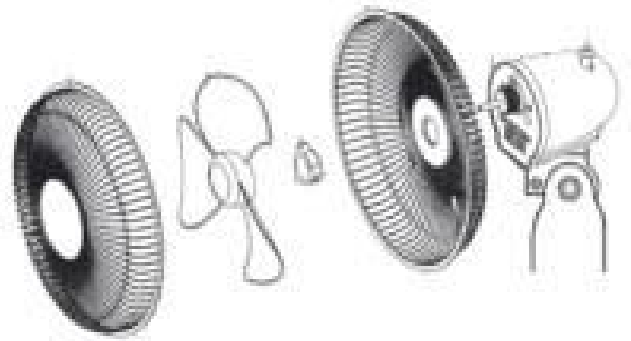

- Slide fan blade onto the motor spindle ensuring that notches on the rear line up with the splir shaft.
- Screw on the Blade Retaining Nut in anticlockwise direction.
- Hang the front guard over the top of the rear guard and push the clips inwards until the front guard is fastened to the rear guard.
- Finally fit the nut and screw through the hole in the bottom edge of the front guard arrowed and tighten it.

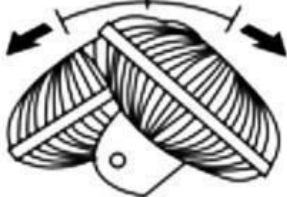

USE

- Unroll the power cord completely.
- Check that the tension in force in the country where you are corresponds to that indicated on the apparatus.
- Connect the apparatus in a correct socket-outlet, (and connected to the ground if the unit is Class I), to avoid any danger.
- Disconnect the power source cable before any operation of cleaning of maintenance and accessories assembly.
- Never modify the appliance in anyway.

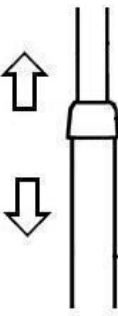
<p>This fan has three types of speed control .</p> <p>Strong 3</p> <p>Middle 2 Piano switches of wind adjusting</p> <p>Work 1</p> 	 <p>Stop waving</p>  <p>Press the oscillate control knob, the fan begins to wave. Pull the button, the fan stops waving.</p>
 <p>You can choose the up and down angle and control the wind direction freely.</p>	 <p>Extend upper pipe, insert the pipe connector through upper pipe onto lower pipe and tighten.</p>

CONTROL PANEL INSTRUCTION

The above button on this panel is inactive for this fan !!!

NO FUNCTION !

REMOTE CONTROL

All buttons are the same as below explanations.

M / VITESSE (ON / Speed)

Press the “M/Vitesse” button to turn the fan on.

When the fan is turned on it will start at the speed setting.

Select the desired speed by pressing the “M/Vitesse” (ON / Speed) button.

Once : Speed 1 will be on and the corresponding pilot light for speed 1 will light.

Twice : Speed 2 will be on and the corresponding pilot light for speed 2 will light.

3 times : Speed 3 (max) will be on and the corresponding pilot light for speed 3 will light.



TIMER

Select between the different setting time, by pressing the timer button, Each time the valour changes : 30 min / 1h / 2h /4h. (and back to 30min). The fan will stay on for the selected amount of time.

MODE FUNCTION

Switch the Mode button between normal and sleep mode.

On “normal mode” : The motor will run continuously.

On “sleep mode” the motor will run discontinuously. It's normal !

ARRÊT (Off function)



Push “ Arrêt ” (Off) button to stop the programs & the fan.
That ensure that all keys are inactive and the fan is not is use.

CLEANING AND MAINTENANCE

Before cleaning, always: switch off the appliance, disconnect the apparatus and let it cool.

Clean the outside of the apparatus with a sponge or slightly wet linen.

Do not use abrasive cleaners, gritting, or metal brush or another cutting object.

The greasy dirt of the fan fuselage and fan blade should be cleaned so as not to change its colour or be damaged.

Don't clean it with water directly.

Don't wipe it with acid detergent, lamp oil, alcohol or chemical cloth in case its colour be changed or go bad.

STORAGE

-Ensure the unit is completely cool and dry.

-Do not wrap the cord around the appliance, as this will cause damage.

-Keep the appliance in a cool, dry place and out of reach from children.

GUARANTEE

Before being delivered, all our products are subjected to a rigorous control. This apparatus is guaranteed 24 months starting from the date of purchase. The documents in proof of guarantee are:

- The invoice and
- The filled and stamped warranty plate (located on side or bottom of the gift box). Without these documents in proof, no free replacement, nor no free repair, can be carried out.

During the warranty period, we deal for free, the defects of the apparatus or the accessories, rising from a defect of materials or manufacture by repair or, replacement. The services within the framework of the guarantee do not involve any extension of the warranty period and does not give right to a new guarantee! In the event of recourse to the guarantee, bring back the complete apparatus to your retailer, in its original packing, accompanied by the proofs of purchase.

The breakage of parts out of glass or plastic is, in all the cases, not warranted. Defects on the accessories or the wearing parts (for example: coils of engines, hooks, drive belts, remote control of replacement, teeth brushes of replacement, webs etc) as well as cleaning, maintenance or it replacement of wearing parts are not guaranteed and are thus to pay!

In the event of foreign intervention, the guarantee becomes null and void.

After flow of the warranty period, repairs can be carried out, against payment, by a specialized trade or a repair service.

SPECIFICATIONS

Power supply	220-240V~ 50/60Hz
Power	45W
Norm	Class II
Maximum flow rate	43.43m ³ /min
Fan power input	40.0W
Service value	1.09(m ³ /min)/W
Maximum air velocity	3.164 meters/sec
Standby power consumption	0.49W
Fan sound power level	52.4dB(A)
Seasonal electricity consumption	13.349kWh/a

Measurement standard for service value	COMMISSION REGULATION (EU) No. 206/2012, Point 2(d) of annex Implementing Directive 2009/125/EU EN 50564:2011 EN 60704-1:2010+A11:2012 EN 60704-2-7:1998 IEC 60879:1986(corr.1992)
---	--

Made in P.R.C

The characteristics can change without preliminary preventing

CAUTION: In order to minimize the risks of electric shock, In the event of breakdown, not to open the case but to call upon a qualified technician for repairs.

This device complies with EC directives, it was controlled according to all current European directives, applicable such as: electromagnetic compatibility (EMC) and low voltage (LVD).

This device has been designed and manufactured in compliance with the latest regulations and technical requirements for safety.

**Imported by Sotech International
" LE PERIPOLE " N°A107
33, Avenue du Marechal de Lattre de Tassigny
94120 Fontenay sous Bois - France**